

Programmable Logic Controllers



Selection Guide.....2

MicroSmart Family.....3

NEW MicroSmart Pentra CPU Part Numbers..... 7

MicroSmart CPU Part Numbers 8

Expansion Modules..... 10

Programming Software - WindLDR 23

Specifications & Dimensions 24

OpenNet Controller 45

IEDEC SmartRelay 56

Selection Guide..... 58

Programming Software - WindLGC 60

Specifications & Dimensions 61



For more information on this product family, visit our website.

Additional resources include:

- New and updated product information
- Downloadable software demos & upgrades
- Part configuration tool & cross reference
- Online stock check & ordering
- IDEC field sales & distributor search
- Online literature request
- Downloadable manuals & CAD drawings
- Manufacturer's suggested retail price list
- Product training schedule & locations
- Advertising & trade show schedules
- Press releases & FAQs

Selection Guide

Programmable Logic Controllers

PLCs









Operator Interfaces

Automation Software

Power Supplies

Sensors

Communication & Networking

	MicroSmart Family		OpenNet Controller (ONC)	SmartRelay	
	MicroSmart Pentra	MicroSmart			
Page	3	8	45	56	
Appearance					
Rated Voltage	24V DC, 100-240V AC	24V DC, 100-240V AC	24V DC	12-24V DC, 24V AC/DC, 100-240V AC/DC	
Max. Digital I/O	512	264	480	50	
Max. Analog I/O	56	56	42	10	
Program Capacity	62.4K bytes	31.2K bytes	32K bytes	2K bytes	
Max. Communication Ports	7	2	3	1	
Networking	Modbus RTU/ASCII	Yes	-	-	
	Modbus TCP	Yes	-	-	
	AS-Interface	Yes	Yes	-	Yes
	LONWORKS	-	-	-	Yes
32-bit Data	Yes	-	Yes	-	
Floating Point Math	Yes	-	-	-	
High-Speed I/O Freq.	100KHz	20KHz	10KHz	2KHz	
Approvals					

MicroSmart Pentra



Micro-controllers play an increasingly central role in today's industrial applications. You have many controllers to choose from, but the one you turn to most often is the one that fits best, physically and practically. You'll find IDEC PLCs in various applications from water treatment plants to HVAC to printing press operations and more. They're always dependable, easy to program and almost as smart as you are.

IDEC brought some of the first micro-PLCs to the market, and has been meeting your changing control automation needs for decades. Now with the MicroSmart Pentra, you get the fastest and most full featured programmable logic controller there is.



International Approvals

All MicroSmart controllers have regulatory agency certifications for the worldwide market including being cULus Listed for Class1 Division 2 Hazardous Locations, TUV approved, CE, and certified for marine use by ABS and Lloyd's Registry.

Write & Run Your Programs Now

Relax. Programming the MicroSmart is fast and straightforward. Use IDEC's WindLDR software to configure, modify and monitor your MicroSmart programs with ease. This powerful and intuitive software makes it simple to get your system up and running.

Rugged, Compact, Modular Design

Every CPU module comes equipped with embedded I/O points, and you can conveniently add snap-on expansion modules for up to 512 I/Os based on your system requirements. All MicroSmart controllers are DIN-rail or panel mountable.

Upgrade Without Downtime

For added convenience, the same expansion I/O modules and accessories can be used on both the MicroSmart and MicroSmart Pentra controllers. In fact, both controllers share the same architecture, instruction set and programming software. The use of a single software platform for all IDEC PLCs means you won't have to reprogram or learn a new system to move from one to another.



MicroSmart Pentra Performance

The Fastest Micro Controller in its Class!

MicroSmart Pentra is the fastest micro controller available in its class. The overall processing speed of the new Logic Engine CPU is 16 times faster than our competitor's average controller.

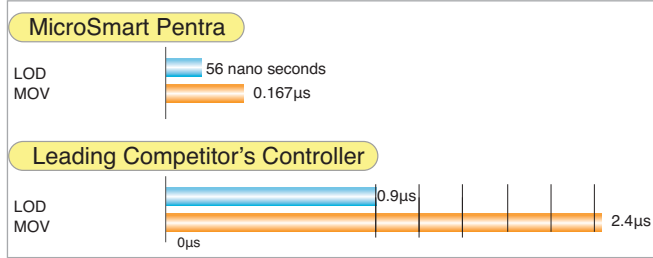

Supports 32-bit data and floating point math

MicroSmart Pentra supports double-word, floating point math operations, capturing and storing large values, and returning computed results accurate to seven decimal places.

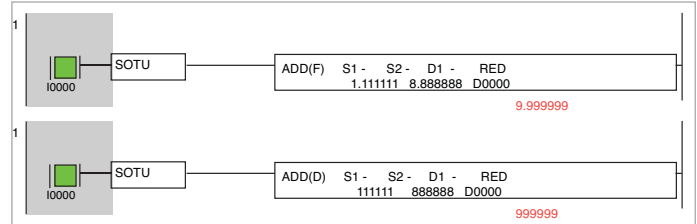

Field Upgradeable Firmware

Extend the life of your PLC! Upgrade your firmware on-site as new functions and versions become available.



Built-in Modbus RTU/ASCII master & slave, and Modbus TCP (1:1) de-facto protocol

Modbus messaging protocol is a de-facto protocol in industrial networking. Communication with other devices on a Modbus network can be easily achieved with built-in Macros instructions.

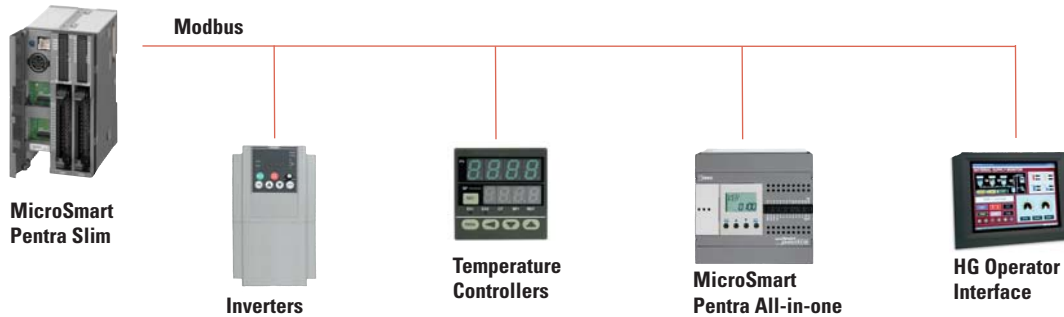

PLCs

Operator Interfaces

Automation Software

Power Supplies

Sensors

Communication & Networking

MicroSmart Pentra Performance

Maximum 7 Communication Ports

MicroSmart Pentra models can accommodate up to a total of seven communication ports. Now you can connect your HMI, PC, barcode reader, RFID equipment, printer and more.



Integrated 100KHz Fast Inputs and Outputs

Configure up to four high-speed inputs from high-speed output devices such as rotary encoders or proximity switches at a maximum frequency of 100KHz, independent of the scan time. Up to three high-speed outputs can be used for simple positioning controls for stepper or servo motors.

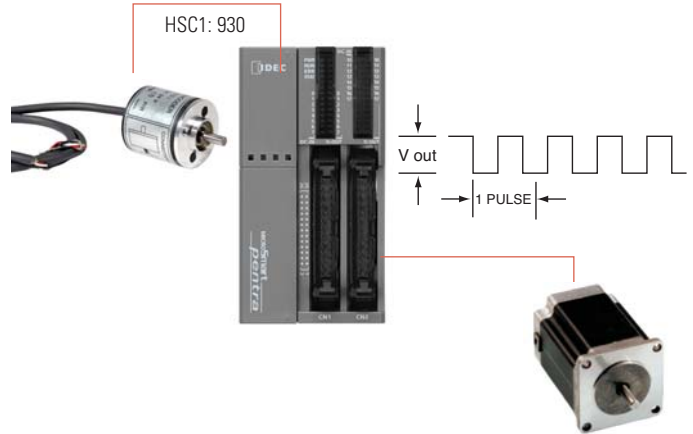

56 PID Loops

PID is the standard solution to many industrial process controls because of its accuracy and stability. With up to 56 PID loops and advanced auto-tuning features, your systems can be tuned to optimum values for the desired control response.

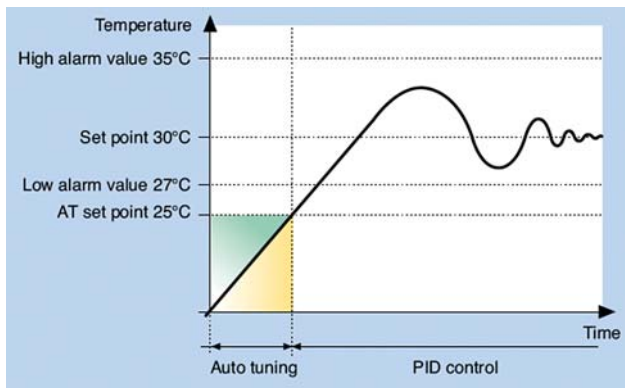

Maximum 56 Analog I/O

Your options include 0-10V, 4-20mA, RTD, thermocouple, thermistor inputs and +/-10V output. With built-in Macro instructions, configuring analog parameters is just a step away.

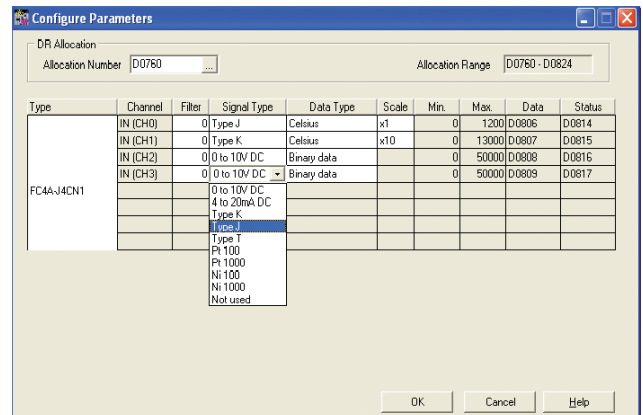

Compact & Modular Design

All-in-One CPU



Optional RS232C adapter



Optional RS485 adapter



Optional RS485 adapter - screw type

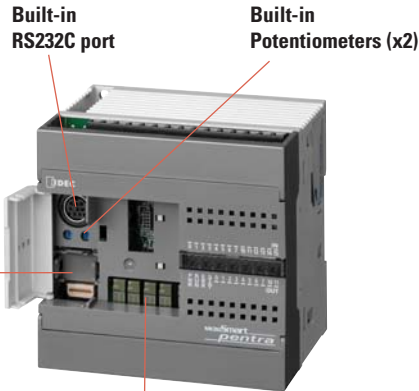

All-in-one CPU



Optional HMI module for monitoring



FC5A-C24R2C



Optional EEPROM memory cartridge



Optional Real Time Clock cartridge

Slim CPU

Optional HMI module for monitoring



Optional HMI base module or RS232C/RS485 Comm. Modules



Built-in Potentiometer

Built-in 0-10V analog input



Slim CPU

Built-in RS232C port



Optional Real Time Clock cartridge



Optional EEPROM memory cartridge

PLCs

Operator Interfaces

Automation Software

Power Supplies

Sensors

Communication & Networking

MicroSmart Pentra CPU Part Numbers

All-in-One

Appearance	Part Number	Power	I/O Points	Input	Output	Expandability
	FC5A-C10R2C	24V DC	10 (6 in/4 out)	24V DC (Sink/Source)	Relay	N/A
	FC5A-C10R2	100-240V AC				
	FC5A-C16R2C	24V DC	16 (9 in/7 out)			
	FC5A-C16R2	100-240V AC				
	FC5A-C24R2C	24V DC	24 (14 in/10 out)			
	FC5A-C24R2	100-240V AC				

Slim

Appearance	Part Number	Power	I/O Points	Input	Output	Expandability	
	FC5A-D16RK1	24V DC	16 (8 in/8 out)	24V DC (Sink/Source)	6 Relays, 2 Transistor Sink	496 Maximum I/O (up to 15 expansion modules)	
	FC5A-D16RS1				6 Relays, 2 Transistor Source		
	FC5A-D32K3*		32 (16 in/16 out)		32 (16 in/16 out)	Transistor Sink	512 Maximum I/O (up to 15 expansion modules)
	FC5A-D32S3*					Transistor Source	



*See page 20 for MIL Connector Cables and Breakout Modules.

PLCs

Operator Interfaces

Automation Software

Power Supplies

Sensors

Communication & Networking

MicroSmart Performance

Features:

- Available in 10, 16, 20, 24, and 40 I/O CPUs.
- PID Controls
 - Program up to 14 PID loops
- High Speed I/O
 - Built-in 4 high speed inputs
 - Single or Dual Phase
 - Max. 20KHz frequency
- Built-in 2 High speed outputs (Slim model only)
- Configure up to 264 I/O Points
- Data link up to 32 MicroSmart and Pentra CPUs
- Using RS485 communication module/port, you can create a network of up to 32 CPUs.
- Worldwide Approvals
 - cULus listed, CE marked
 - Class 1 Div. 2 for hazardous locations
 - Lloyds Registered and ABS approved for shipping industry



PLCs

Operator Interfaces

Automation Software

Power Supplies

Sensors

Communication & Networking



MicroSmart CPU Part Numbers

All-in-One

Appearance	Part Number	Power	I/O Points	Input	Output	Expandability	
	FC4A-C10R2C	24V DC	10 (6 in/ 4 out)			N/A	
	FC4A-C10R2	100-240V AC					
	FC4A-C16R2C	24V DC	16 (9 in/ 7 out)	24V DC (Sink/Source)	Relay		
	FC4A-C16R2	100-240V AC					
	FC4A-C24R2C	24V DC	24 (14 in/ 10 out)				88 Maximum I/O (up to 4 expansion modules)
	FC4A-C24R2	100-240V AC					

MicroSmart CPU Part Numbers

Slim

Appearance	Part Number	Power	I/O Points	Input	Output	Expandability			
	FC4A-D20RK1	24V DC	20 (12 in/8 out)	24V DC (Sink/Source)	6 Relays, 2 Transistor Sink	244 Maximum I/O (up to 7 expansion modules)			
	FC4A-D20RS1				6 Relays, 2 Transistor Source				
	FC4A-D20K3				Transistor Sink	148 Maximum I/O (up to 7 expansion modules)			
	FC4A-D20S3				Transistor Source				
	FC4A-D40K3				40 (24 in/16 out)			Transistor Sink	264 Maximum I/O (up to 7 expansion modules)
	FC4A-D40S3							Transistor Source	

PLCs

Operator Interfaces

Automation Software



Power Supplies

Sensors







Communication & Networking

Starter Kits and Solution Packages

MicroSmart Starter Kits

		Part Numbers	Controller	Power Supply	Software (Prog. Cables Included)
MicroSmart		MM-SMART-10	10 I/O All-in-One CPU	–	WindLDR
		MM-SMART-16	16 I/O All-in-One CPU	–	WindLDR
		MM-SMART-20	20 I/O Slim CPU	15W	WindLDR
		MM-SMART-24	24 I/O All-in-One CPU	–	WindLDR
		MM-SMART-40	40 I/O Slim CPU	15W	WindLDR
MicroSmart Pentra		MM-PENTRA-16	16 I/Os Slim CPU	30W	WindLDR
		MM-PENTRA-24	24 I/Os All-in-One CPU	–	WindLDR

MicroSmart Solution Packages

		Part Numbers	Operator Interface*	Controller	Power Supply
MicroSmart		MM-SMART-16-HG2F-M	HG2F 5.7" Mono STN	16 I/O All-in-One CPU	15W
		MM-SMART-20-HG2F-M	HG2F 5.7" Mono STN	20 I/O Slim CPU	60W
		MM-SMART-24-HG2F-M	HG2F 5.7" Mono STN	24 I/O All-in-One CPU	15W
		MM-SMART-40-HG2F-M	HG2F 5.7" Mono STN	40 I/O Slim CPU	60W
		MM-SMART-16-HG2F-C	HG2F 5.7" Color STN	16 I/O All-in-One CPU	15W
		MM-SMART-20-HG2F-C	HG2F 5.7" Color STN	20 I/O Slim CPU	60W
		MM-SMART-24-HG2F-C	HG2F 5.7" Color STN	24 I/O All-in-One CPU	15W
		MM-SMART-40-HG2F-C	HG2F 5.7" Color STN	40 I/O Slim CPU	60W
		MM-SMART-20-HG3F	HG3F 10.4" Color TFT	20 I/O Slim CPU	60W
		MM-SMART-24-HG3F	HG3F 10.4" Color TFT	24 I/O All-in-One CPU	60W
		MM-SMART-20-HG4F	HG4F 12.1" Color TFT	20 I/O Slim CPU	60W
		MM-SMART-24-HG4F	HG4F 12.1" Color TFT	24 I/O All-in-One CPU	60W
MicroSmart Pentra		MM-PENTRA-16-HG1F	HG1F 4.6" Mono STN	16 I/O Slim CPU	30W
		MM-PENTRA-24-HG1F	HG1F 4.6" Mono STN	24 I/O All-in-One CPU	30W
		MM-PENTRA-16-HG2F-C	HG2F 5.7" Color STN	16 I/O Slim CPU	30W
		MM-PENTRA-24-HG2F-C	HG2F 5.7" Color STN	24 I/O All-in-One CPU	30W
		MM-PENTRA-16-HG3F	HG3F 10.4" Color TFT	16 I/O Slim CPU	30W
		MM-PENTRA-24-HG3F	HG3F 10.4" Color TFT	24 I/O All-in-One CPU	30W
		MM-PENTRA-16-HG4F	HG4F 12.1" Color TFT	16 I/O Slim CPU	30W
		MM-PENTRA-24-HG4F	HG4F 12.1" Color TFT	24 I/O All-in-One CPU	30W



- *HG1F: Light Gray Bezel, RS232 Comm., HG2F/3F/4F: Light Gray Bezel.
- All packages come with WindLDR & WindO/I-NV2 software, programming and interface cables.

Solution Packages







Whether you want to give IDEC products a try or already use them but want a complete automation system that is quick and easy to put together, you'll find a great deal in our solution packages. Each package includes an IDEC operator interface:

- HG1F – 4.6" STN monochrome LCD touchscreen
- HG2G – 5.7" STN 256 color or monochrome LCD touchscreen
- HG3F – 10.4" TFT 256 color LCD touchscreen
- HG4F – 12.1" TFT 256 color LCD touchscreen

They also include a MicroSmart or MicroSmart Pentra PLC (Slim or All-in-One design), a slim power supply, cables and software. Buy one package and you're ready to go.



Control at your fingertips

		Part Numbers			Operator Interface**	Controller Type	Power Supply
MicroSmart		MM-SMART-20-HG3F			HG3F 10.4" Color TFT	20 I/O Slim CPU	60W
		MM-SMART-24-HG3F			HG3F 10.4" Color TFT	24 I/O All-in-One CPU	60W
		MM-SMART-20-HG4F			HG4F 12.1" Color TFT	20 I/O Slim CPU	60W
		MM-SMART-24-HG4F			HG4F 12.1" Color TFT	24 I/O All-in-One CPU	60W
MicroSmart Pentra		MM-PENTRA-16-HG1F			HG1F 4.6" Mono STN	16 I/O Slim CPU	30W
		MM-PENTRA-24-HG1F			HG1F 4.6" Mono STN	24 I/O All-in-One CPU	30W
		MM-PENTRA-16-HG2G-EM			HG2G 5.7" Mono STN, Ethernet	16 I/O Slim CPU	30W
		MM-PENTRA-24-HG2G-M			HG2G 5.7" Mono STN	24 I/O All-in-One CPU	30W
		MM-PENTRA-24-HG2G-EM			HG2G 5.7" Mono STN, Ethernet	24 I/O All-in-One CPU	30W
		MM-PENTRA-16-HG2G-EC			HG2G 5.7" Color STN, Ethernet	16 I/O Slim CPU	30W
		MM-PENTRA-24-HG2G-C			HG2G 5.7" Color STN	24 I/O All-in-One CPU	30W
		MM-PENTRA-24-HG2G-EC			HG2G 5.7" Color STN, Ethernet	24 I/O Slim CPU	30W
		MM-PENTRA-16-HG3F			HG3F 10.4" Color TFT	16 I/O Slim CPU	30W
		MM-PENTRA-24-HG3F			HG3F 10.4" Color TFT	24 I/O All-in-One CPU	30W
		MM-PENTRA-16-HG4F			HG4F 12.1" Color TFT	16 I/O Slim CPU	30W
		MM-PENTRA-24-HG4F			HG4F 12.1" Color TFT	24 I/O All-in-One CPU	30W

WindLDR Programming Software

Unique ladder logic programming tool designed to program all IDEC PLCs

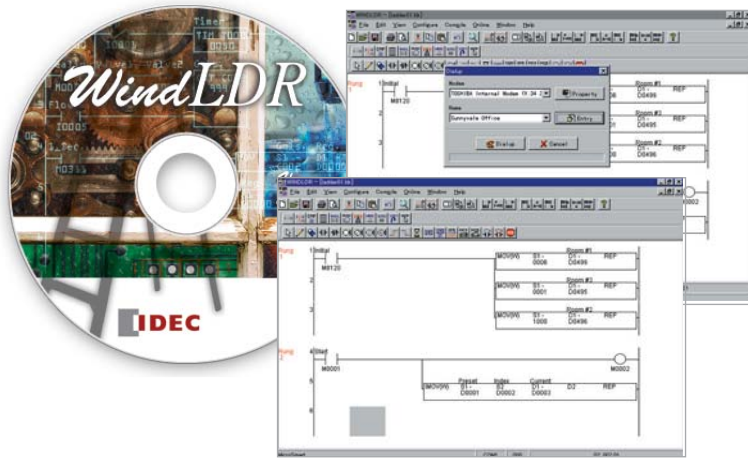

Part Number

Part Number	Description
FC9Y-LP2CDW	WindLDR PLC programming software

Single Platform for all IDEC PLCs

WindLDR is an excellent, long-term investment for your control solutions. It programs every IDEC PLC including the OpenNet Controller, MicroSmart and the fastest micro-controller on the market, MicroSmart Pentra. It's adaptable to whatever hardware you need today and down the road.

Simple-to-use Editors

Use the tag editor to access and edit coil data. Edit comments and rung comments. Simulation mode tests your program in WindLDR to guarantee that it works the way you expected, before downloading it to your PLC.

User-friendly Interfaces

Icon-based toolbars and drag-and-drop functionality make basic ladder programming accessible to anyone. But WindLDR also shows you how to display parameters and settings and how to input your parameters, and the built-in shortcuts and tutorials will keep you on the right track.

Free Lifetime Upgrade

Not only is WindLDR the easiest and most convenient ladder programming software on the market, it also comes with a very special price with no strings attached. Our software comes with a free-lifetime upgrade. That means that you no longer need to spend thousands of dollars for software that has to be renewed every year costing you additional money. Save yourself money by using an IDEC PLC and WindLDR programming software.

Specifications

All-in-One

Part Number	AC Power	FC5A-C10R2	FC5A-C16R2	FC5A-C24R2	FC4A-C10R2	FC4A-C16R2	FC4A-C24R2
	DC Power	FC5A-C10R2C	FC5A-C16R2C	FC5A-C24R2C	FC4A-C10R2C	FC4A-C16R2C	FC4A-C24R2C
Rated Voltage	AC power model: 100 to 240V AC, DC power model: 24V DC						
Allowable Voltage Range	AC power model: 85 to 264V AC, DC power model: 20.4 to 28.8V DC (including ripple)						
Rated Power Frequency	AC power model: 50/60 Hz (47 to 63 Hz)						
Maximum Input Current	250mA (85V AC) 160mA (24V DC)	300mA (85V AC) 190mA (24V DC)	450mA (85V AC) ¹ 360mA (24V DC) ²	250mA (85V AC) 160mA (24V DC)	300mA (85V AC) 190mA (24V DC)	450mA (85V AC) ² 360mA (24V DC) ³	
Maximum Power Consumption	AC Power	FC5A-C10R2/FC4A-C10R2: 30VA (264V AC) / 20VA (100V AC) ³ FC5A-C16R2/FC4A-C16R2: 31VA (264V AC) / 22VA (100V AC) ³ FC5A-C24R2/FC4A-C24R2: 40VA (264V AC) / 33VA (100V AC) ¹					
	DC Power	FC5A-C10R2C/FC4A-C10R2C: 3.9W (24V DC) ⁴ FC5A-C16R2C/FC4A-C16R2C: 4.6W (24V DC) ⁴ FC5A-C24R2C/FC4A-C24R2C: 8.7W (24V DC) ²					
Allowable Momentary Power Interruption	10ms (rated power voltage)						
Dielectric Strength	Between power and ⊕ or ⊖ terminals: 1500V AC, 1 minute Between I/O and ⊕ or ⊖ terminals: 1500V AC, 1 minute						
Insulation Resistance	Between power and ⊕ or ⊖ terminals: 10 MΩ minimum (500V DC megger) Between I/O and ⊕ or ⊖ terminals: 10 MΩ minimum (500V DC megger)						
Noise Resistance	AC power terminals: 1.5 kV, 50 ns to 1μs DC power terminals: 1.0 kV, 50 ns to 1μs I/O terminals (coupling clamp): 1.5 kV, 50 ns to 1μs						
Inrush Current		35A	40A	35A	40A		
Power Supply Wire	UL1015 AWG22, UL1007 AWG18						
Operating Temperature	0 to 55°C						
Storage Temperature	-25 to +70°C (no freezing)						
Relative Humidity	Level RH1 (IEC61131-2), 1 to 95% RH (no condensation)						
Altitude	Operation: 0 to 2,000m, Transport: 0 to 3,000m						
Pollution Degree	2 (IEC60664-1)						
Corrosion Immunity	Free from corrosive gases						
Degree of Protection	IP20 (IEC60529)						
Grounding Wire	UL1007, AWG16						
Vibration Resistance	When mounted on a DIN rail or panel surface: 5 to 9 Hz amplitude 3.5 mm, 9 to 150 Hz acceleration 9.8 m/s ² (1G), 2 hours per axis on each of three mutually perpendicular axes (IEC61131-2)						
Shock Resistance	147 m/s ² (15G), 11ms duration, 3 shocks per axis, on three mutually perpendicular axes (IEC61131)						
Weight	AC: 230g DC: 240g	AC: 250g DC: 260g	AC: 305g DC: 310g	AC: 230g DC: 240g	AC: 250g DC: 260g	AC: 305g DC: 310g	

- 1. CPU module (including 250mA sensor power) + 4 I/O modules
- 2. CPU module + 4 I/O modules
- 3. CPU module (including 250mA sensor power)
- 4. CPU module (24V DC)

PLCs
Operator Interfaces
Automation Software
Power Supplies
Sensors
Communication & Networking

Slim

Part Number		FC5A-D16RK1 FC5A-D16RS1	FC5A-D32K3 FC5A-D32S3	FC4A-D20K3 FC4A-D20S3	FC4A-D20RK1 FC4A-D20RS1	FC4A-D40K3 FC4A-D40S3					
Control System		Stored program system									
Instruction Words		35 basic									
Program Capacity ¹		88 advanced	92 advanced	55 advanced	72 advanced						
User Program Storage		EEPROM (10,000 times rewritable)									
Processing Time	Basic Instruction	83µs (1,000 steps)			1.65ms (1,000 steps)						
	END Processing ³	0.35ms			0.64ms						
Expandable I/O Modules		7 modules + additional 8 modules using the expansion power supply module			7 modules						
I/O Points	Input	8	Expansion: 224 Additional: 256	16	Expansion: 224 Additional: 256	12	Expansion: 128	12	Expansion: 224	24	Expansion: 224
	Output	8	Expansion: 224 Additional: 256	16	Expansion: 224 Additional: 256	8	Expansion: 128	8	Expansion: 224	16	Expansion: 224
Internal Relay		2,048 points			1,024 points						
Shift Register		256 points			128 points						
Data Register		42,000 points ⁴			1,300 points						
Expansion Data Register		6,000 points			—			6,000 points			
Counter		256 points			100 points						
Timer (1-sec, 100-ms, 10-ms, 1-ms)		256 points			100 points						
RAM Backup	Backup Data	Internal relay, shift register, counter, data register, expansion data register									
	Backup Duration	Approx. 30 days (typical) at 25°C after backup battery fully charged									
	Battery	Lithium secondary battery									
	Charging Time	Approx. 15 hours for charging from 0% to 90% of full charge									
	Battery Life	5 years									
Replaceability		N/A									
Self-diagnostic Function		Power failure, watchdog timer, data link connection, user program EEPROM sum check, timer/counter preset value sum check, user program RAM sum check, keep data, user program syntax, user program writing, CPU module, clock IC, I/O bus initialize, user program execution									
Input Filter		Without filter or 3 to 15ms filter (selectable in increments of 1ms)									
Catch Input/Interrupt Input		Four inputs (I2 through I5) Minimum turn on pulse width: 5µs minimum Minimum turn off pulse width: 5µs minimum			Four inputs (I2 through I5) Minimum turn on pulse width: 40µs minimum Minimum turn off pulse width: 150µs minimum						
High-speed Counter	Maximum Counting Frequency and High-speed Counter Points	Total 4 points Single/two-phase selectable: 100 KHz (2 points) Single-phase: 100 KHz (2 points)			Total 4 points Single/two-phase selectable: 20 KHz (2 points) Single-phase: 5 KHz (2 points)						
	Counting Range	0 to 4294967295 (32 bits)			0 to 65535 (16 bits)						
	Operation Mode	Rotary encoder mode and adding counter mode									
Analog Potentiometer	Number	1 point									
	Data Range	0 to 255									
Analog Voltage Input	Number	1 point									
	Input Voltage Range	0 to 10V DC									
	Input Impedance	Approx. 100kΩ									
	Data Range	0 to 255 (8 bits)									
Pulse Output	Number	2 points	3 points	2 points							
	Maximum Frequency	100KHz			20KHz						
Sensor Power Supply	Output Voltage Current	—									
	Isolation	—									
Port 1		RS232C (maintenance communication, user communications)									
Port 2 Communication Adapter (option) ⁵		Possible	Possible	Possible	Possible	Possible					
Clock Cartridge (option)		Possible	Possible	Possible	Possible	Possible					
Memory Cartridge (option)		Possible	Possible	Possible	Possible	Possible					
HMI Module (option)		Possible	Possible	Possible	Possible	Possible					



- 1 step equals 6 bytes.
- Expandable up to 64 KB when a memory cartridge is used.
- Not including expansion I/O service time, clock function processing time, data link processing time, and interrupt processing time.
- Extra data registers D10000 through D49999 are enabled using WindLDR

- Function Area Settings, then run-time program download cannot be used.
 - Maintenance communication, user communication, Modem communication, data link, Modbus master/slave communication (FC5A only).
- Note: The maximum number of relay outputs that can be turned on simultaneously is 54 including those on the CPU module.

PLCs

Operator Interfaces

Automation Software

Power Supplies

Sensors

Communication & Networking

All-in-One

Part Number		FC5A-C10R2 FC5A-C10R2C	FC5A-C16R2 FC5A-C16R2C	FC5A-C24R2 FC5A-C24R2C	FC4A-C10R2 FC4A-C10R2C	FC4A-C16R2 FC4A-C16R2C	FC4A-C24R2 FC4A-C24R2C		
Control System		Stored program system							
Instruction Words		35 basic							
Program Capacity ¹		13.8 KB (2,300 steps)	27 KB (4,500 steps)	54 KB (9,000 steps)	4.8 KB (800 steps)	15 KB (2,500 steps)	27 KB (4,500 steps)		
User Program Storage		EEPROM (10,000 times rewritable)							
Processing Time	Basic Instruction	1.16ms (1,000 steps)			1.65ms (1,000 steps)				
	END Processing ²	0.64ms			0.64ms				
Expandable I/O Module		—		4 modules	—		4 modules		
I/O Points	Input	6	9	14	Expansion: 64	6	9	14	Expansion: 64
	Output	4	7	10		4	7	10	
Internal Relay		2,048 points			256 points	1,024 points			
Shift Register		128 points			64 points	128 points			
Data Register		2,000 points			400 points	1,300 points			
Extra Data Register		—			—				
Counter		256 points			32 points	100 points			
Timer (1-sec, 100-ms, 10-ms, 1-ms)		256 points			32 points	100 points			
RAM Backup	Backup Data	Internal relay, shift register, counter, data register							
	Backup Duration	Approx. 30 days (typical) at 25°C after backup battery fully charged							
	Battery	Lithium secondary battery							
	Charging Time	Approx. 15 hours for charging from 0% to 90% of full charge							
	Battery Life	5 years							
	Replaceability	N/A							
Self-diagnostic Function		Power failure, watchdog timer, data link connection, user program EEPROM sum check, timer/counter preset value sum check, user program RAM sum check, keep data, user program syntax, user program writing, CPU module, clock IC, I/O bus initialize, user program execution							
Input Filter		Without filter or 3 to 15ms filter (selectable in increments of 1ms)							
Catch Input/Interrupt Input		Four inputs (I2 through I5) Minimum turn on pulse width: 40µs minimum Minimum turn off pulse width: 150µs minimum							
High-speed Counter	Maximum Counting Frequency and High-speed Counter Points	Total 4 points Single/two-phase selectable: 50KHz (1 point) Single-phase: 5KHz (3 points)			Total 4 points Single/two-phase selectable: 20KHz (1 point) Single-phase: 5KHz (3 points)				
	Counting Range	0 to 65535 (16 bits)							
	Operation Mode	Rotary encoder mode and adding counter mode							
Analog Potentiometer	Number	1 point		2 points	1 point		2 points		
	Data Range	0 to 255							
Analog Voltage Input	Number	—							
	Input Voltage Range	—							
	Input Impedance	—							
Pulse Output	Data Range	—							
	Number	—							
Sensor Power Supply (AC Power Only)	Max. Frequency	—							
	Output Voltage Current	24V DC (+10% to -15%), 250mA							
	Overload Detection	N/A							
Isolation		Isolated from the internal circuit							
Port 1		RS232C (maintenance communication, user communication)							
Port 2 Communication Adapter (option) ³		Possible	Possible	Possible	—	Possible	Possible		
Clock Cartridge (option)		Possible	Possible	Possible	Possible	Possible	Possible		
Memory Cartridge (option)		Possible	Possible	Possible	Possible	Possible	Possible		
HMI Module (option)		Possible	Possible	Possible	Possible	Possible	Possible		



- 1 step equals 6 bytes.
 - Not including expansion I/O service time, clock function processing time, data link processing time, and interrupt processing time.
 - Maintenance communication, user communication, Modem communication, datalink, Modbus master/slave communication (FC5A only).
- Note: The maximum number of relay outputs that can be turned on simultaneously is 33 including those on the CPU module.

PLCs

Operator Interfaces

Automation Software

Power Supplies

Sensors

Communication & Networking

Communication Port (RS232C Port 1)

Model	Slim CPU	All-in-One CPU
Standards	EIA RS232C	
Maximum Baud Rate	FC5A: 57,600 bps (maintenance communication) FC4A: 19,200 bps (maintenance communication)	
Maintenance Communication	Possible	
User Communication	Possible	
Modem Communication	N/A	
Data Link	N/A	
Cable	Special cable (FC2A-KC4C, FC2A-KP1C, FC4A-KC1C, FC4A-KC2C)	
Isolation between Internal Circuit and Communication Port	Not isolated	

Input Specifications

Part Number	—	FC5A-D16RK1 FC5A-D16RS1	—	FC5A-D32K3 FC5A-D32S3	—	FC5A-C10R2 FC5A-C10R2C	FC5A-C16R2 FC5A-C16R2C	FC5A-C24R2 FC5A-C24R2C
	FC4A-D20K3 FC4A-D20S3	—	FC4A-D20RK1 FC4A-D20RS1	—	FC4A-D40K3 FC4A-D40S3	FC4A-C10R2 FC4A-C10R2C	FC4A-C16R2 FC4A-C16R2C	FC4A-C24R2 FC4A-C24R2C
Input Points	12 (12/1 common)	8 (8/1 common)	12 (12/1 common)	16 (8/1 common)	24 (12/1 common)	6 (6/1 common)	9 (9/1 common)	14 (14/1 common)
Input Voltage	24V DC sink/source input signal							
Input Voltage Range	20.4 to 26.4V DC					20.4 to 28.8V DC		
Input Current	FC5A I0, I1, I3, I4, I6, I7: 4.5mA/point (24V DC) I2, I5, I10 to I17: 7mA/point (24V DC) FC4A I0, I1, I6, I7: 5mA/point (24V DC) I2 to I5, I10 to I27: 7mA/point (24V DC)					FC5A I0 and I1: 6.4mA/point I2 to I7, I10 to I15: 7mA/point (24V DC) FC4A I0 and I1: 11mA I2 to I7, I10 to I15: 7mA/point (24V DC)		
Input Impedance	FC5A I0, I1, I3, I4, I6, I7: 4.9kΩ I2 to I5, I10 to I17: 3.4kΩ FC4A I0, I1, I6, I7: 5.7kΩ I2 to I5, I10 to I17: 3.4kΩ					FC5A I0 and I1: 3.7kΩ I2 to I7, I10 to I15: 3.4kΩ FC4A I0 and I1: 2.1kΩ I2 to I7, I10 to I15: 3.4kΩ		
Turn ON Time	FC5A I0, I1, I3, I4, I6, I7: 5μs + filter value I2 and I5: 35μs + filter value I10 to I17: 40μs + filter value FC4A I0, I1, I6, I7: 35μs + filter value I2 to I5: 35μs + filter value I10 to I27: 40μs + filter value					FC5A I0 and I1: 2μs + filter value I2 to I7: 35μs + filter value I6, I7, I10 to I15: 40μs + filter value FC4A I0 and I1: 35μs + filter value I2 to I5: 35μs + filter value I6, I7, I10 to I15: 40μs + filter value		
Turn OFF Time	FC5A I0, I1, I3, I4, I6, I7: 5μs + filter value I2 and I5: 150μs + filter value I10 to I17: 150μs + filter value FC4A I0, I1, I6, I7: 45μs + filter value I2 to I5: 150μs + filter value I10 to I27: 150μs + filter value					FC5A I0 and I1: 16μs + filter value I2 to I7: 150μs + filter value I6, I7, I10 to I15: 150μs + filter value FC4A I0 and I1: 45μs + filter value I2 to I5: 150μs + filter value I6, I7, I10 to I15: 150μs + filter value		
Connector	On Mother Board	FL26A2MA (Oki Electric Cable)	MC1.5/18-G-3.81BK (Phoenix Contact)	FL26A2MA (Oki Electric Cable)	—			
	Insertion Durability	100 times minimum					—	
Isolation	Between input terminals: Photocoupler isolated Internal circuit: Not isolated							
Input	Type 1 (IEC61131-2)							
External Load for I/O Interconnection	Not needed							
Single Determination Method	Static							
Effect of Improper Input Connection	Both sinking and sourcing input signals can be connected. If any input exceeding the rated value is applied, permanent damage may be caused.							
Cable Length	3 m in compliance with electromagnetic immunity							

PLCs

Operator Interfaces

Automation Software

Power Supplies

Sensors

Communication & Networking

Dimensions (mm)

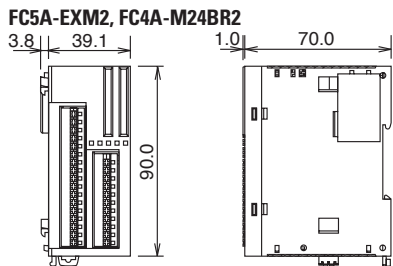
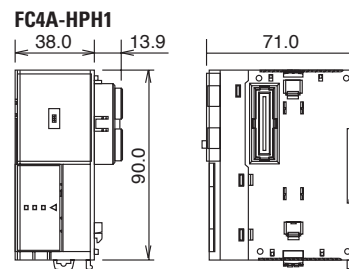
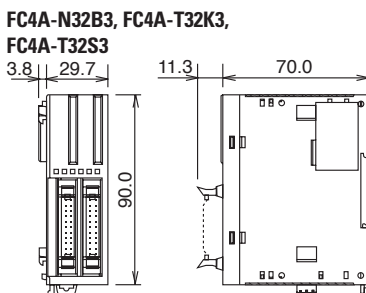
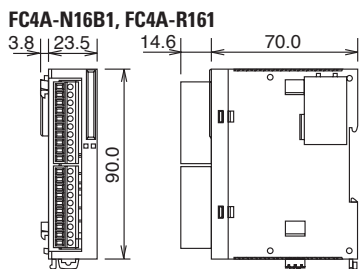
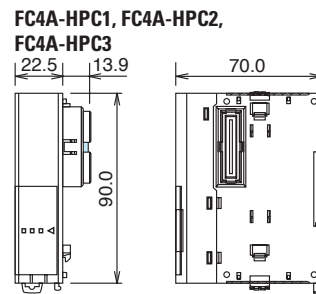
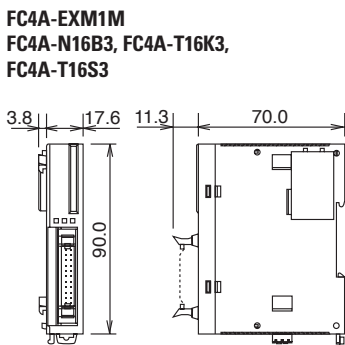
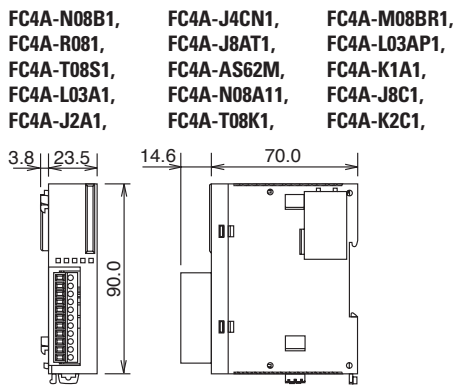
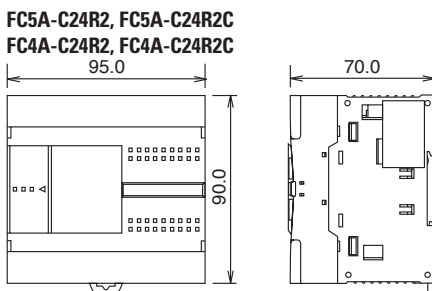
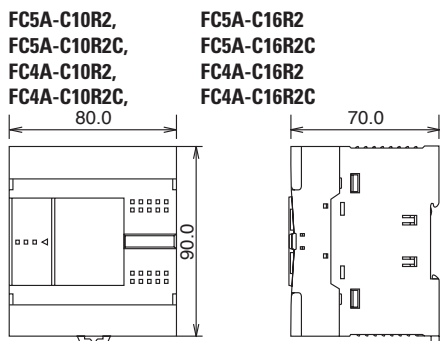
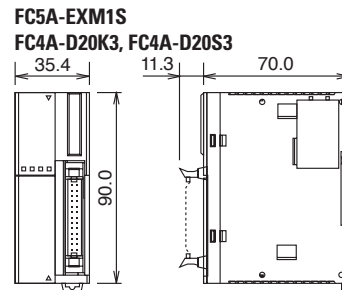
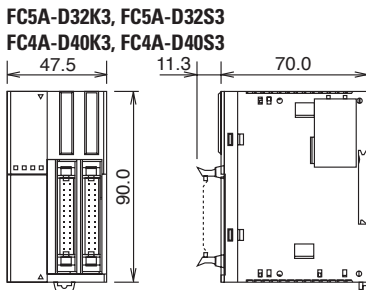
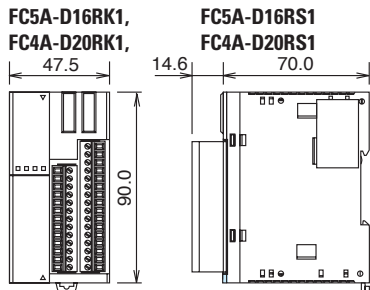

Example

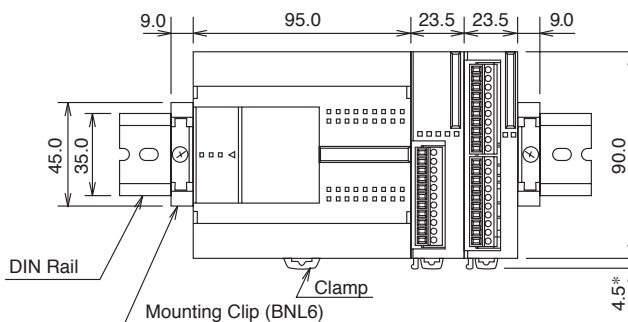

The figure illustrates a system setup consisting of the all-in-one 24-I/O CPU module, an 8-point relay output module, and a 16-point DC input module mounted on a 35-mm-wide-DIN rail using BNL6 mounting clips.

Mounting Hole Layout (mm)

FC5A-C10R2, FC5A-C16R2
 FC5A-C10R2C, FC5A-C16R2C
 FC4A-C10R2, FC4A-C16R2
 FC4A-C10R2C, FC4A-C16R2C

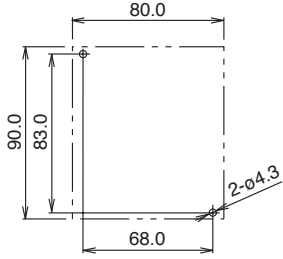

FC4A-N08A11, FC4A-R081
 FC4A-R161, FC4A-T08K1
 FC4A-T08S1, FC4A-M08BR1
 FC4A-L03A1, FC4A-L03AP1
 FC4A-J2A1, FC4A-K1A1
 FC4A-J4CN1, FC4A-T8C1
 FC4A-J8AT1, FC4A-K2C1

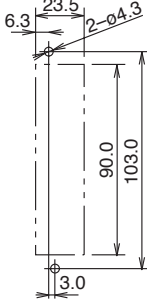

FC5A-EXM2
 FC4A-M24BR2

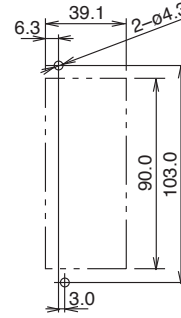

FC5A-EXM1S, FC4A-D20K3
 FC4A-D20S3

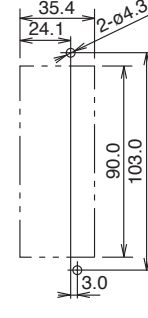

FC5A-C24R2, FC4A-C24R2C
 FC4A-C24R2, FC4A-C24R2C

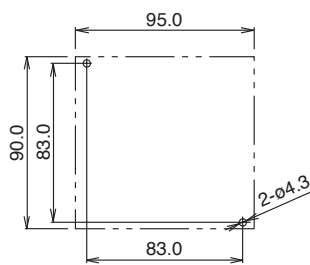

FC5A-EXM1M
 FC4A-N16B3, FC4A-T16K3,
 FC4A-T16S3

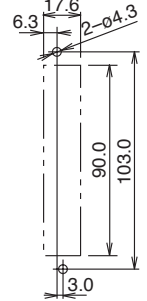

FC4A-HPC1 FC4A-HPC2
 FC4A-HPC3

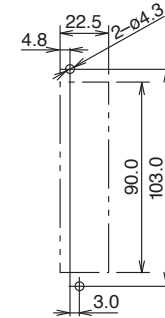

FC4A-N32B3, FC4A-T32K3,
 FC4A-T32S3

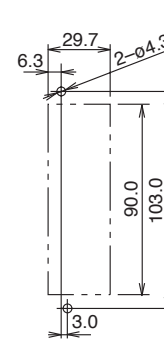

FC5A-D16RK1
 FC5A-D16RS1
 FC5A-D32K3
 FC5A-D32S3
 FC4A-D20RK1
 FC4A-D20RS1
 FC4A-D40K3
 FC4A-D40S3

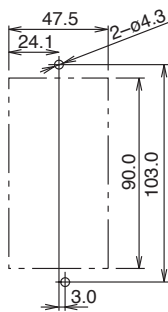

FC4A-HPH1

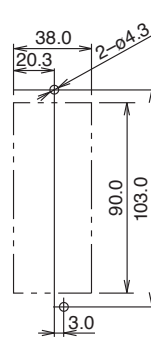

FC4A-HPH1

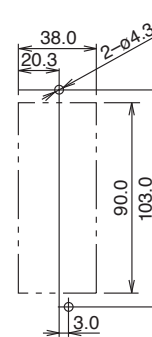

Examples

Mounting hole layout for FC5A-C24R2 or FC4A-C24R2 and four 23.5mm-wide I/O modules

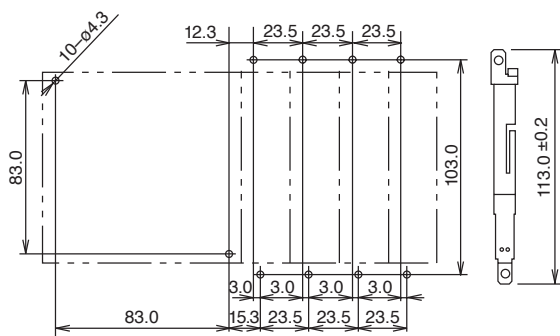

Mounting hole layout from left, FC4A-HPH1, FC4A-D20K3, FC4A-N16B3, FC4A-N32B3, and FC4A-M24BR2 modules

